

# Data Sheet



Article number: 5863502811

Description: Ball Valve 350.2811, G 3/4" - G 3/4"  
Thread/Thread

## Measures

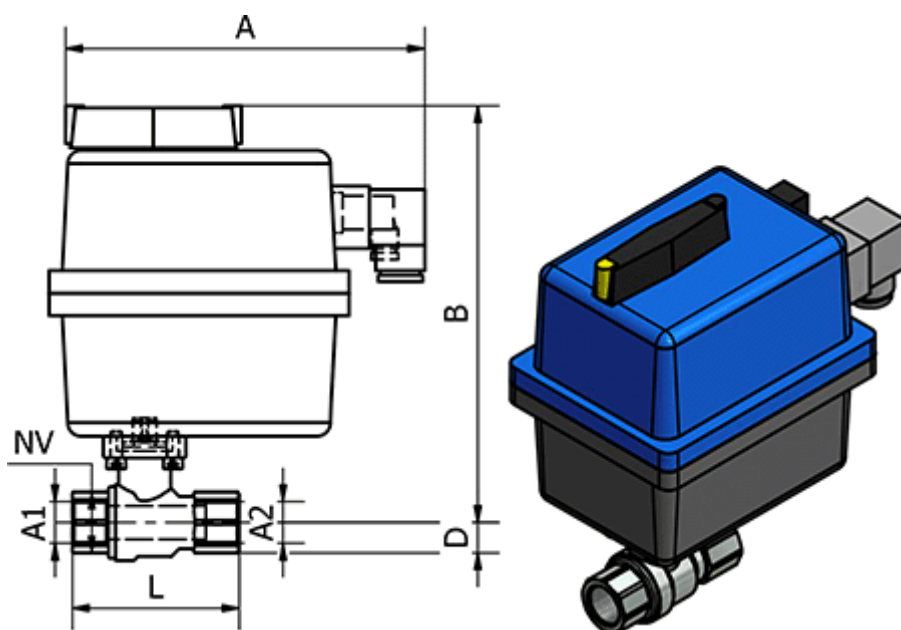

= -	D	= 20
= -	L	= 80
= -	Max. Operating Pressure	= 40 bar
= -	NV	= 32

A = 177

B = 214

Connecting A1 = G 3/4"

Connecting A2 = G 3/4"